



FITTING INSTRUCTIONS FOR

Out-Back Maxtrax Lite Mount

SKU

KS0750

COMPATIBILITY

Out-Back Spare Tyre or Centre Hub Mount

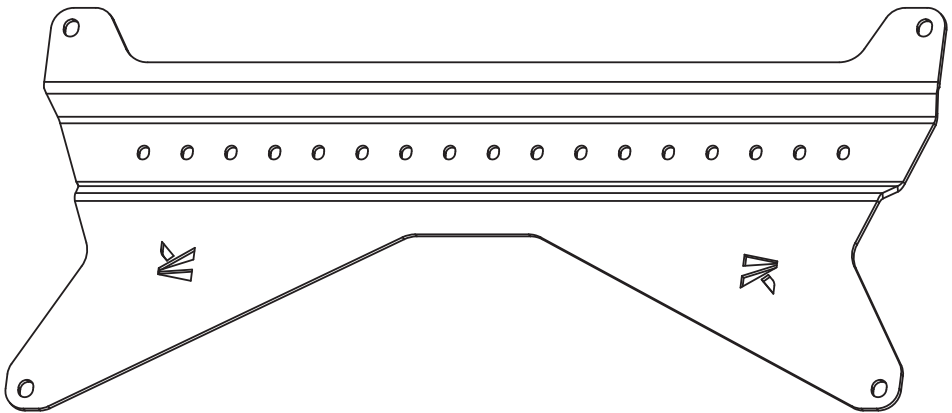

Included contents

QTY	COMPONENT
1	Out-Back Maxtrax Lite Mount
2	M8 x 20 Hex Head Bolt
2	M8 Nyloc Nut
4	M8 x 24 x 2.0 DIN Washer

Also required

QTY	COMPONENT
1	Out-Back Spare Tyre Mount & Strap OR Out-Back Centre Hub Mount
4	Maxtrax Mounting Pin



Time

5 minutes / A sip of beer!

For further information contact KAON on **07 3180 1470** or info@kaon.com.au

It all works together.

Our Out-Back Mounting System is designed to work together, but there is an order to installing based on the mount you are using for your spare wheel.

The following instructions will vary, based on which Out-Back Mount you are using:

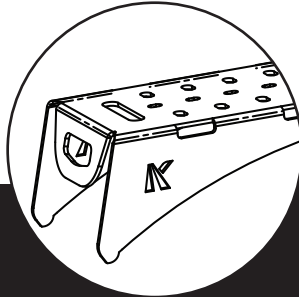

OUT-BACK REAR SPARE MOUNT

Will need to be installed in conjunction with the accessory mounts to the vehicle

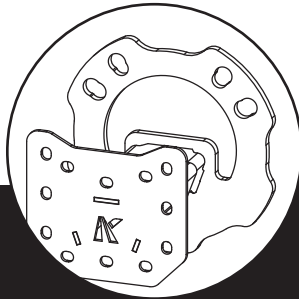

OUT-BACK CENTRE HUB MOUNT

Will need to be partially installed to the vehicle prior to the accessory mounts.

MAXTRAX / TRED MOUNT

Will require mounting pins as an additional component

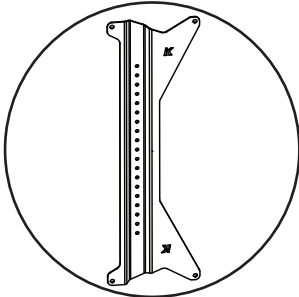

MAXTRAX MINI MOUNT

Will require Maxtrax mounting pins as an additional component

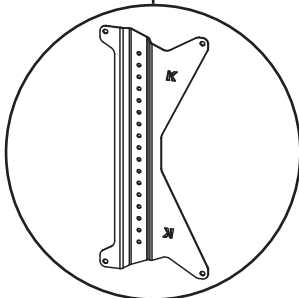
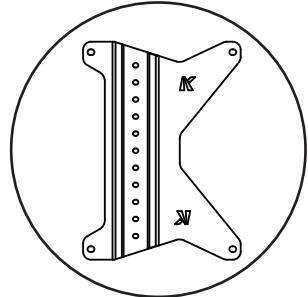

MAXTRAX LITE MOUNT

Will require Maxtrax mounting pins as an additional component

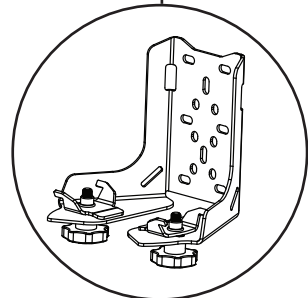

GAS BOTTLE MOUNT

Check local legislation before installing with a Centre Hub Mount

Bolt Torque

DIAMETER (mm)	5mm	6mm	8mm	10mm	12mm
NEWTON-METRES (Nm)	5 Nm	9 Nm	22 Nm	44 Nm	77 Nm

Let's get to work.

Preparation

1. It's best if we get the mounting pins attached to the Maxtrax Mounts first. If you ordered a set of pins, these will have been included. If you already had some, that's great! If you've lost them, we know a place you can buy some...
2. The genuine Maxtrax Mounting Pin Set contains 4 x pins, 4 x nyloc nuts and 4 x washers. We find it easiest to attach the pins to the Maxtrax Mounts by holding the pin in place with a spanner, while using a socket to tighten the nut.
3. Ensure the final position of the pin matches the same orientation as the keyholes of your Maxtrax.



Out-Back Rear Spare Mount Installation

4. Attach the Maxtrax Mount to the Spare Tyre Mount. We recommend sitting the mounts up against the tyre to work out what positioning will work best for your setup, ensuring that your rear door or rear bar swingaway are able to open unaffected.
5. Secure the Maxtrax Mount to the Spare Tyre Mount using the M8 bolts, nuts and washers.
6. Position the Spare Tyre Mount on the tyre, and secure with the provided ratchet strap. We advise ensuring that the hooks are facing outwards with the ratchet at the top of the tyre.
7. Carefully double check clearance between the product and vehicle by gently opening the rear door until it's fully open. **Failure to do this may result in damage to the product and/or vehicle.**
8. Load on your Maxtrax, lock them in place using the pins and you're ready to hit the road!



If you are using a Out-Back Centre Hub Mount, you will need to follow the installation instructions for it, before proceeding with these instructions.

Out-Back Centre Hub Mount Installation

9. Decide on a desired location, the Maxtrax Lite bracket can be mounted vertically or horizontally, central or offset. Consider things like clearance to the vehicle when the door is shut and open. As well as rear visibility and tow ball access etc.
10. Align the holes on the Maxtrax mount to it's corresponding holes on the Centre Hub Mount bracket. Using the supplied nut, bolt and washers, secure the Maxtrax Lite mount to the Centre Hub bracket.



Installation cont.

11. Using the supplied nut and bolt with a washer on both sides, loosely secure the Centre Hub bracket to its mount.
12. With the bracket loosely attached confirm that everything clears through the doors full range of motion, then tighten fully.
13. Load on your Maxtrax, lock them in place using the pins and you're ready to hit the road!





Local Knowledge & Assistance

We know half the fun of building your dream 4x4 is getting your hands dirty. But we also know that sometimes, things don't go to plan. If in the pursuit to build the ultimate setup you find yourself off-track, we're here to help you get unstuck.

For further information call 07 3180 1470 or email info@kaon.com.au

Disclaimer: The products sold by KAON should not be modified, and are for use only on the vehicles specifically stated. KAON will not be liable for any damages arising out of the use or misuse of its products. It is the customers responsibility to ensure the products are safely and properly used and installed. KAON consistently seeks to improve its products and reserves the right to make changes to any product.