



FITTING INSTRUCTIONS FOR

Out-Back Centre Hub Mount

SKU

KS0750

COMPATIBILITY

Rear-Mounted Spare Wheels

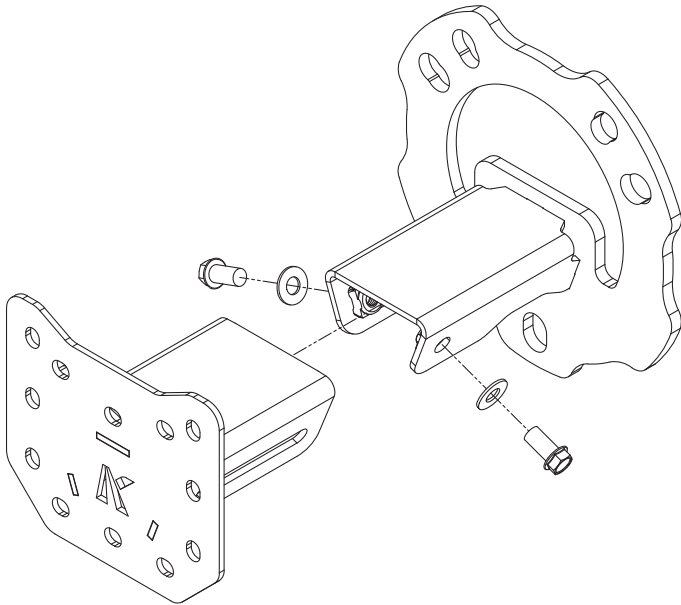

Included contents

QTY	COMPONENT	QTY	COMPONENT
1	Out-Back Hub Mount Bracket	2	M8 x 17 x 1.2 Washer
1	Out-Back Hub Sliding Bracket	2	M8 x 16 Flanged Hex Bolt G8.8

 Time	10 minutes / A couple sips of beer
---	------------------------------------

For further information contact KAON on **07 3180 1470** or info@kaon.com.au

It all works together.

Our Out-Back Mounting System is designed to work together, but there is an order to installing based on the mount you are using for your spare wheel.

The order of installation for accessories will vary depending on which mount you use.

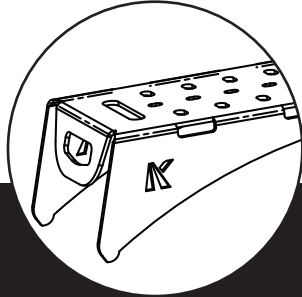

OUT-BACK REAR SPARE MOUNT

Will need to be installed in conjunction with the accessory mounts to the vehicle

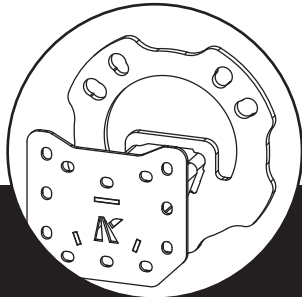

OUT-BACK CENTRE HUB MOUNT

Will need to be partially installed to the vehicle prior to the accessory mounts.

MAXTRAX / TRED MOUNT

Will require mounting pins as an additional component

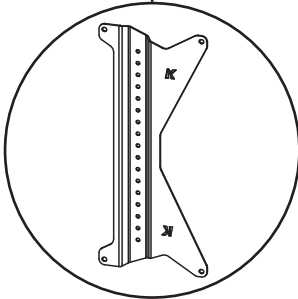
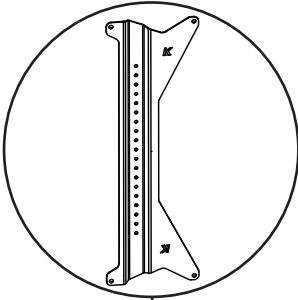

MAXTRAX LITE MOUNT

Will require Maxtrax mounting pins as an additional component

MAXTRAX MINI MOUNT

Will require Maxtrax mounting pins as an additional component

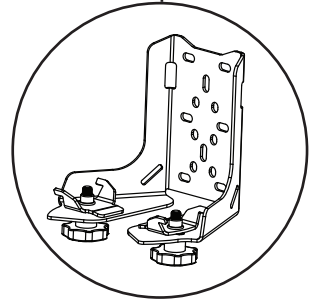
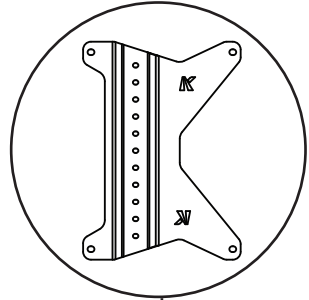

GAS BOTTLE MOUNT

Check local legislation before installing with a Centre Hub Mount

Bolt Torque

DIAMETER (mm)	5mm	6mm	8mm	10mm	12mm
NEWTON-METRES (Nm)	5 Nm	9 Nm	22 Nm	44 Nm	77 Nm

Let's get to work.

Preparation

1. Remove the factory spare wheel, so that the spare wheel studs are exposed.



Installation

2. Slide the Hub Mount Bracket over the spare wheel studs.
3. Refit the spare wheel so the Hub Mount Bracket protrudes from the wheel's centre bore.
4. Check that the Hub Mount Bracket is sitting level, and tighten the spare wheel's bolts.
5. Before attaching the Hub Sliding Bracket to the Hub Mount Bracket, consider what accessories you intend to attach and in what orientation. It is best to loosely position the Hub Sliding Bracket to work out your ideal configuration.

Depending on what accessory you have mounted, you may want the Hub Sliding Bracket and fitted accessory to sit hard against the tyre (e.g. Maxtrax board) or nested inside the rim (e.g. Rotopax or jerry can).

6. We recommend attaching additional accessories prior to completing installation of the Centre Hub Mount, as bolt access is more difficult once the Hub Sliding Bracket is fitted.



Finishing the installation

If you are also installing other Out-Back Accessories:

7. Refer to those instructions to complete your installation.

If you are only installing the Centre Hub Mount:

8. Place the sliding mount over the hub mount and locate it to the wheel.
9. With location established use the supplied M8 bolts and washers to secure the sliding mount on either side. If you're securing something hard against the tyre, be sure to keep pressure on this while tightening.
10. With the Centre Hub Mount installed, you are now ready to use it as a platform for mounting accessories on your rear spare wheel!





Local Knowledge & Assistance

We know half the fun of building your dream 4x4 is getting your hands dirty. But we also know that sometimes, things don't go to plan. If in the pursuit to build the ultimate setup you find yourself off-track, we're here to help you get unstuck.

For further information call 07 3180 1470 or email info@kaon.com.au

Disclaimer: The products sold by KAON should not be modified, and are for use only on the vehicles specifically stated. KAON will not be liable for any damages arising out of the use or misuse of its products. It is the customers responsibility to ensure the products are safely and properly used and installed. KAON consistently seeks to improve its products and reserves the right to make changes to any product.